

MS 202 P

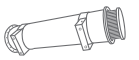

CONSTRUCTION MATERIALS		
SHELL	TUBES	END COVERS
CARBON STEEL*	COPPER*	CAST IRON*
STAINLESS STEEL	STAINLESS STEEL	STAINLESS STEEL
BRASS	CuNi (water sea)	BRONZE



- Dimensions and technical characteristics are not binding

*standard

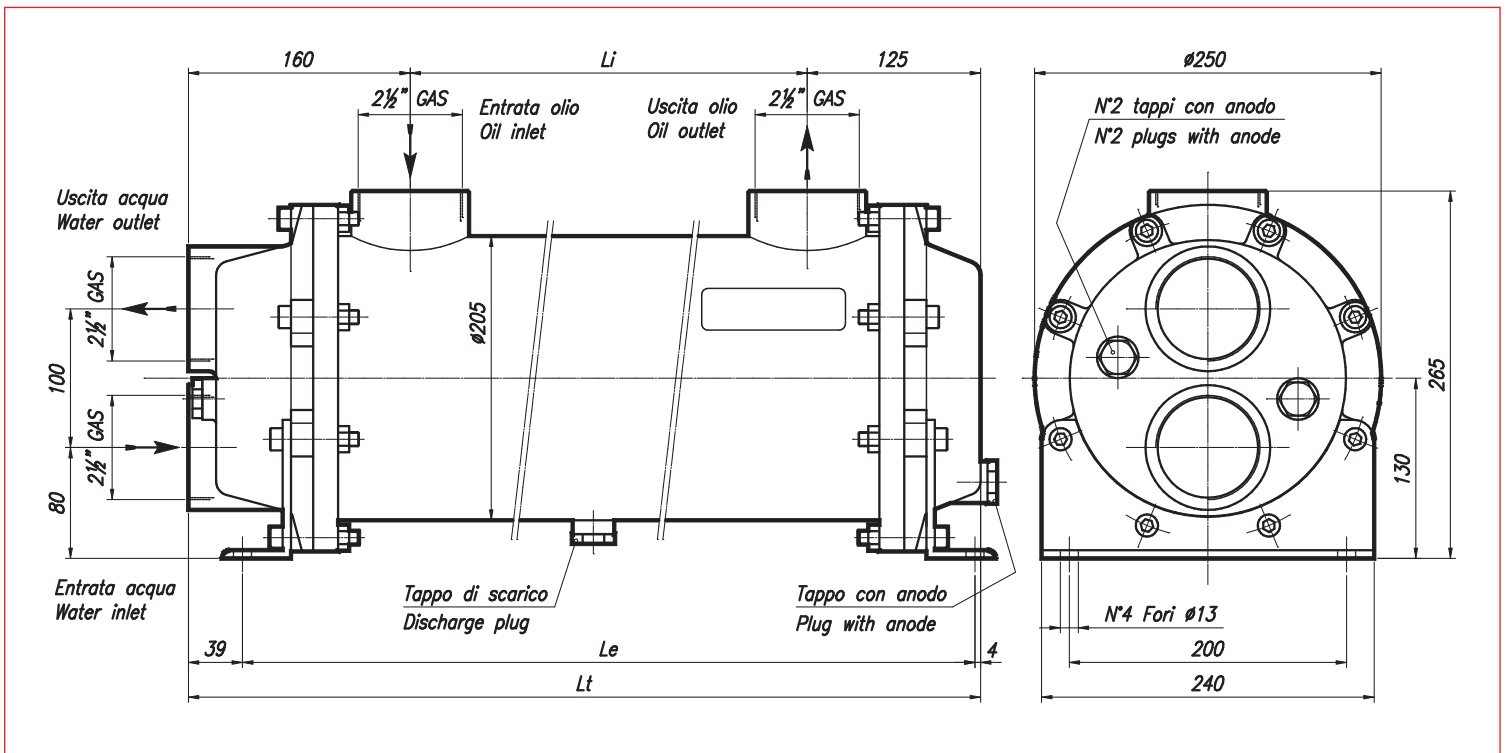

TYPE	CODE	OIL FLOW	WATER FLOW	kW MIN water flow		kW MAX water flow		WEIGHT	DIMENSIONS		
		l/min	l/min	ΔTm 25° C		ΔTm 25° C			kg	Li	Le
MS 202 P1	2SC202P1	100-400	105-420	20	35	24	51	47	340	582	630
MS 202 P2	2SC202P2	160-460	105-420	29	50	39	69	56	500	742	790
MS 202 P3	2SC202P3	280-500	105-420	42	57	56	82	72,5	660	902	950
MS 202 P4	2SC202P4	260-560	105-420	46	76	67	109	84	820	1062	1110
MS 202 P5	2SC202P5	300-600	105-420	56	78	79	125	94	980	1222	1270
MS 202 P6	2SC202P6	340-600	105-420	73	98	98	148	104	1140	1382	1430
MS 202 P7	2SC202P7	280-600	105-420	68	90	92	123	114	1300	1542	1590
MS 202 P8	2SC202P8	200-600	105-420	102	134	141	177	124,5	1460	1702	1750
MS 202 P9	2SC202P9	460-800	105-420	132	168	176	221	135	1620	1862	1910
MS 202 P10	2SC202P10	520-800	105-420	145	197	191	260	145,5	1780	2022	2070

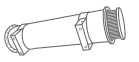

WATER FLOW RATE:



P1 P2 P3

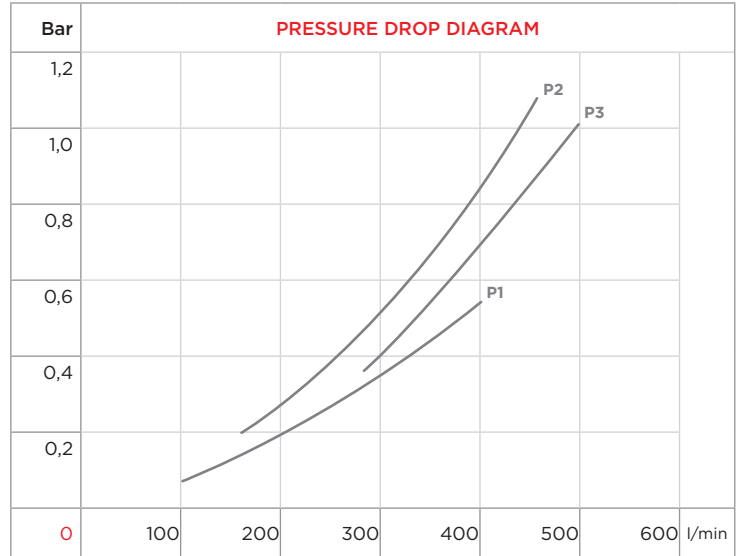

P4 P5 P6

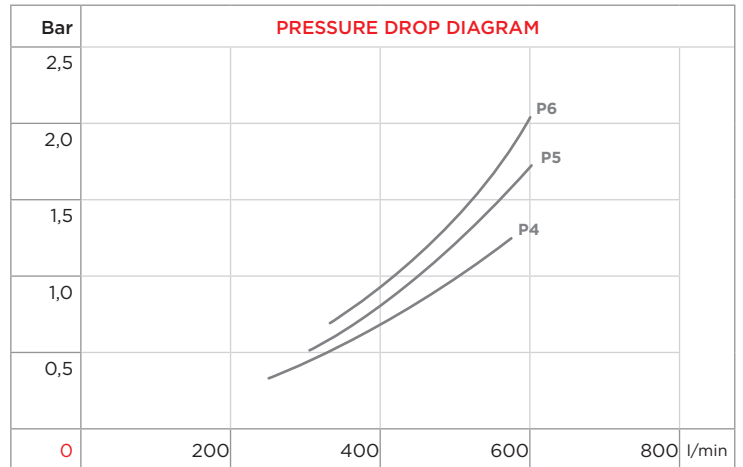
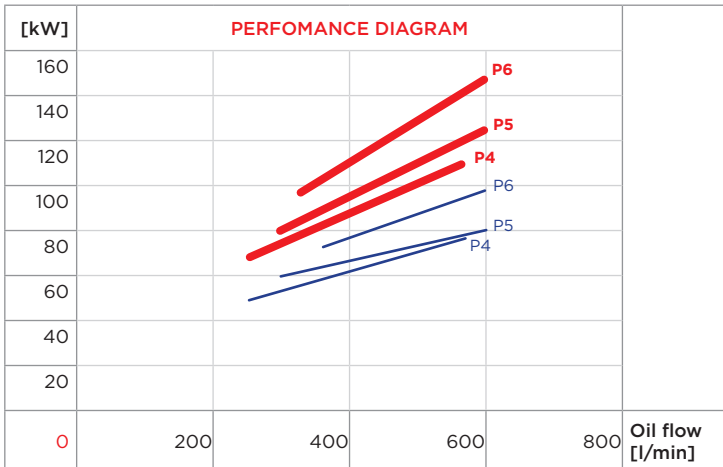

P7 P8 P9 P10

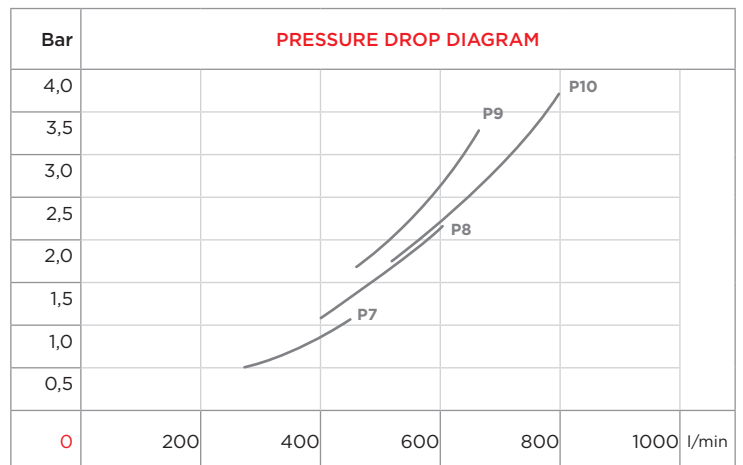
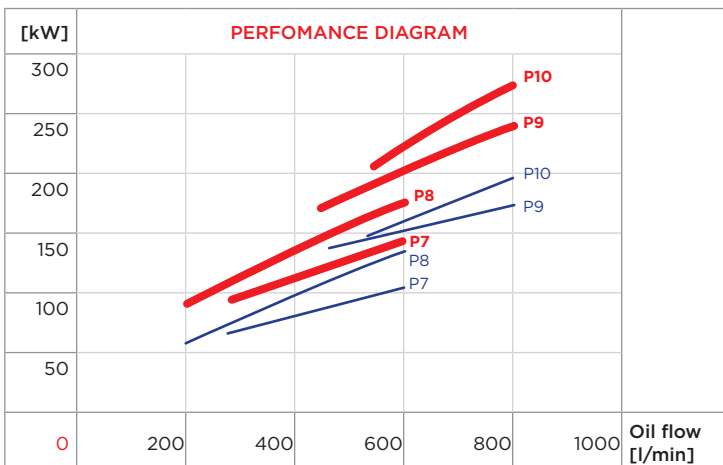

ΔT_m	10	15	20	25	30	35	40
f	2,5	1,67	1,25	1	0,83	0,71	0,63

cSt	22	30	46	68	100	150	220
f	0,4	0,6	1	1,5	2,3	3,3	4,6