

# MS 172/7 P

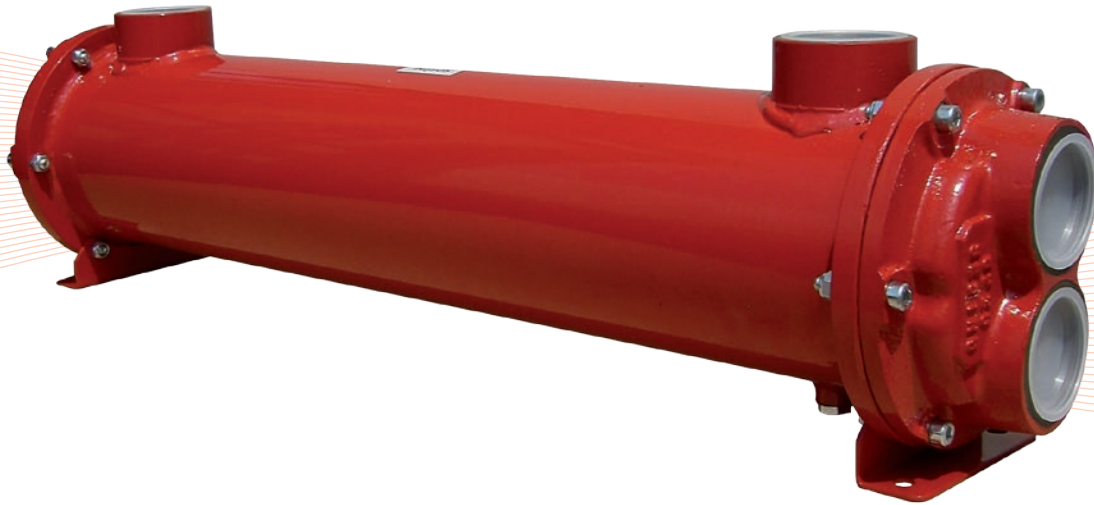
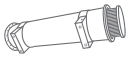

CONSTRUCTION MATERIALS		
SHELL	TUBES	END COVERS
CARBON STEEL*	COPPER*	CAST IRON*
STAINLESS STEEL	STAINLESS STEEL	STAINLESS STEEL
BRASS	CuNi (water sea)	BRONZE

- Dimensions and technical characteristics are not binding

\*standard

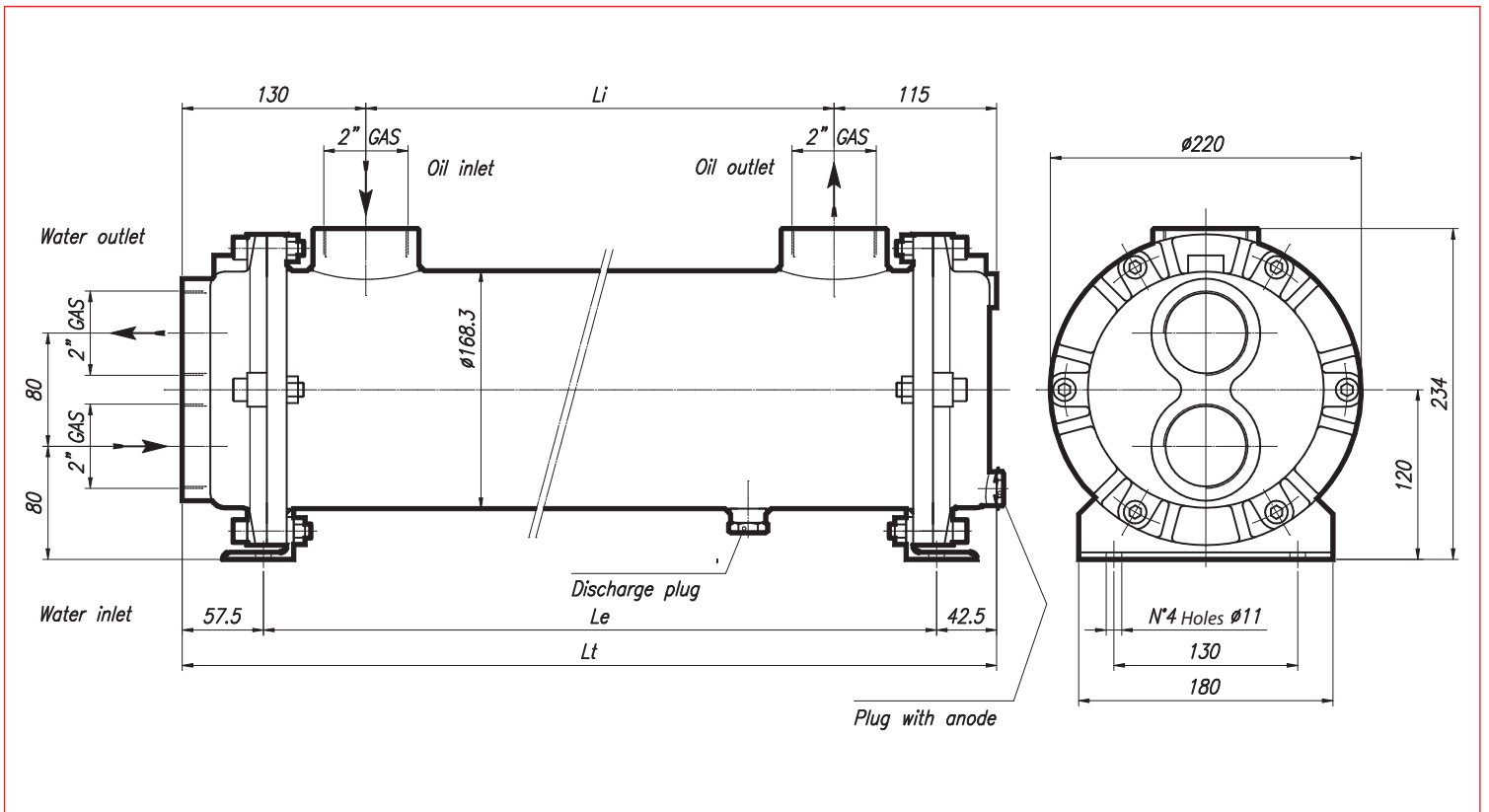

TYPE	CODE	OIL FLOW l/min	WATER FLOW l/min	kW MIN water flow		kW MAX water flow		WEIGHT kg	DIMENSIONS		
				$\Delta T_m$ 25° C		$\Delta T_m$ 25° C			Li	Le	Lt
MS 172/7 P1	2SC172/7P1	100-240	67,5-270	28	34	42	60	42	355	500	600
MS 172/7 P2	2SC172/7P2	160-400	67,5-270	50	57	78	92	50,5	505	650	750
MS 172/7 P3	2SC172/7P3	260-420	67,5-270	63	71	110	136	59	655	800	900
MS 172/7 P4	2SC172/7P4	340-500	67,5-270	76	92	136	171	68,5	830	975	1075
MS 172/7 P5	2SC172/7P5	180-320	67,5-270	88	96	143	170	78	1005	1150	1250
MS 172/7 P6	2SC172/7P6	140-500	67,5-270	89	117	148	230	86	1155	1300	1400
MS 172/7 P7	2SC172/7P7	250-550	67,5-270	113	138	200	267	97	1355	1500	1600

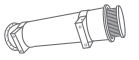

WATER FLOW RATE:



P1 P2

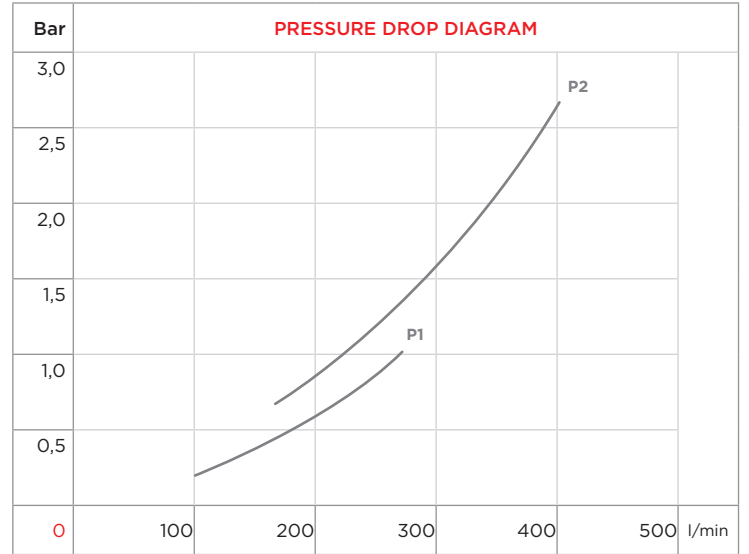
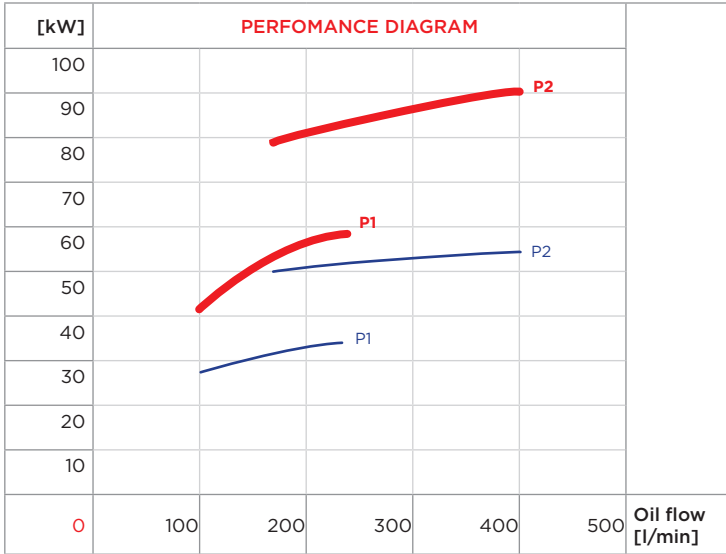

P3 P4

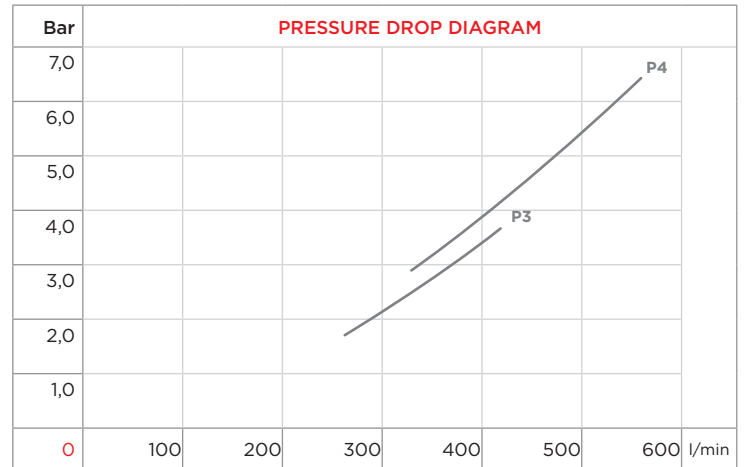
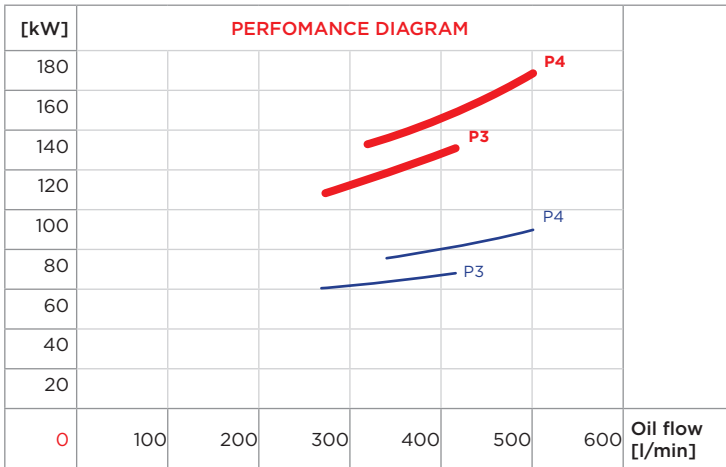

P5 P6 P7

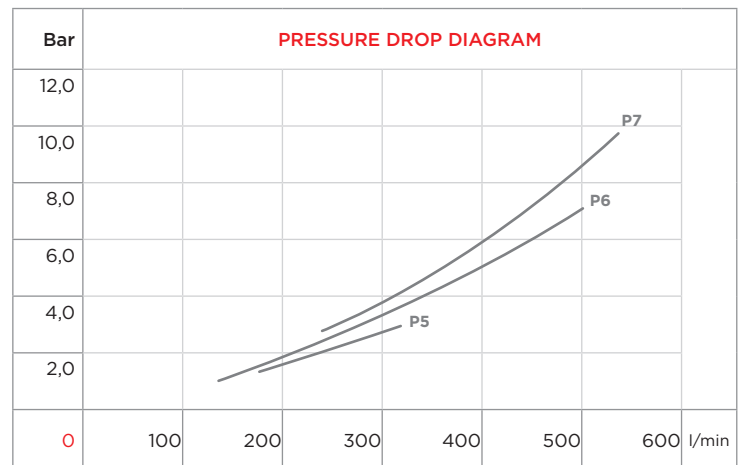
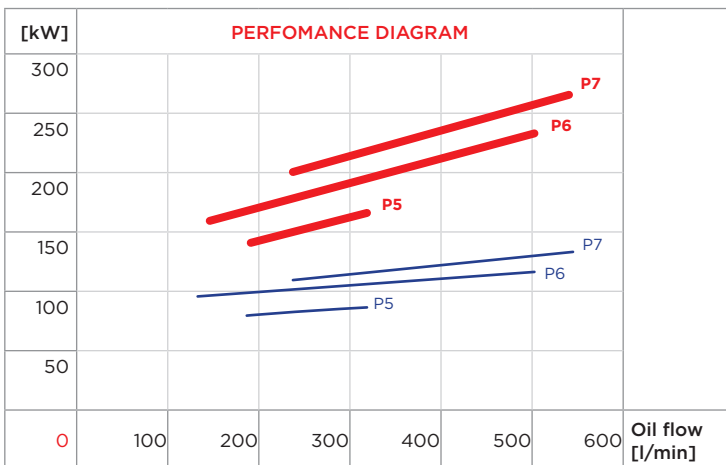

CORRECTION FACTOR							
$\Delta T_m$	10	15	20	25	30	35	40
f	2,5	1,67	1,25	1	0,83	0,71	0,63

CORRECTION FACTOR							
cSt	22	30	46	68	100	150	220
f	0,4	0,6	1	1,5	2,3	3,3	4,6